

Assembly Instructions PENNY Arm Chair

PLEASE NOTE: Check that you have received all components and hardware before assembling. If you are missing any parts fax Euro Style at 415.455.8033 or email: claims@gotoeurostyle.com

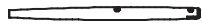

A (1pc)



B (4 pcs)



C (1pc)



D (4 pcs)



E (4 pcs)
M6 x 12mm



F (8 pcs)

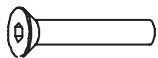

G (8 pcs)
M6 x 35mm



H (8 pcs)



I (1 pc)

1

Attach Part D to Part B as shown in the diagram, then screw Part G to Part B.

Attach Part G to Part B from the side with the countersunk holes.

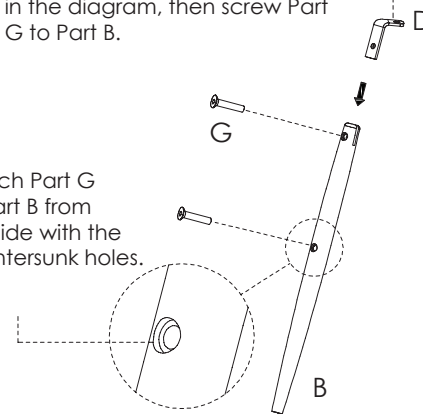

2

Repeat Step 1 and assemble all four legs.

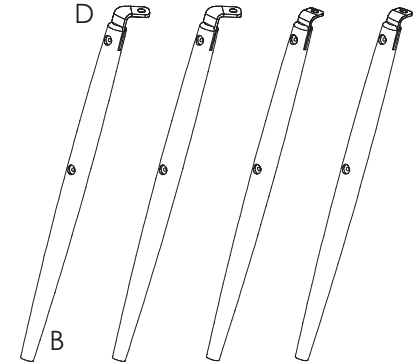

3

Parts D are marked with either "e" or "i." Make sure Parts D marked with "e" are parallel and Parts D marked with "i" are parallel, as shown in the diagram.

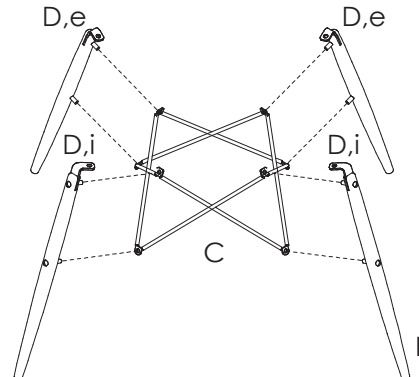

4

Attach nuts to the screws.

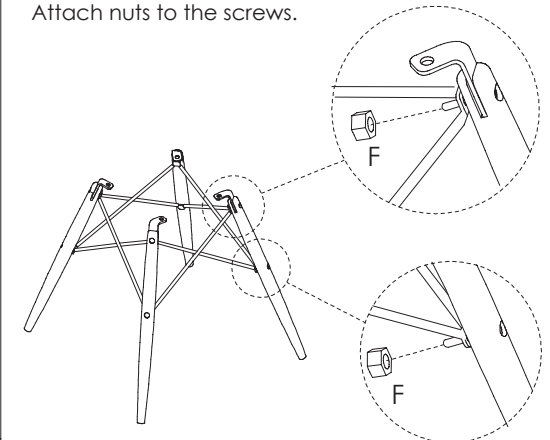

Assembly Instructions PENNY Arm Chair

PLEASE NOTE: Check that you have received all components and hardware before assembling. If you are missing any parts fax Euro Style at 415.455.8033 or email: claims@gotoeurostyle.com



A (1pc)



B (4 pcs)



C (1pc)



D (4 pcs)



E (4 pcs)
M6 x 12mm



F (8 pcs)

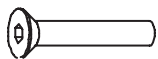

G (8 pcs)
M6 x 35mm



H (8 pcs)



I (1 pc)

5

Parts D marked with "e" must be attached to the front side of the seat. Parts D marked with "i" must be attached to the back side of the seat, as shown in the diagram.

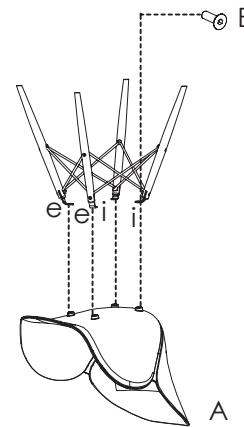

6

Attach the protection caps on the nuts.

H

