

Assembly Instructions NAPOLEON Low Back Office Chair

PLEASE NOTE: Check that you have received all components and hardware before assembling.
If you are missing any parts fax Euro Style at 415.455.8033 or email: claims@gotoeurostyle.com



1

2

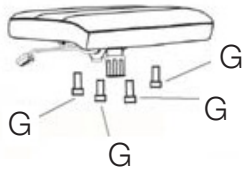
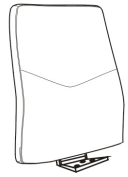
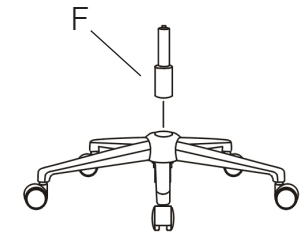
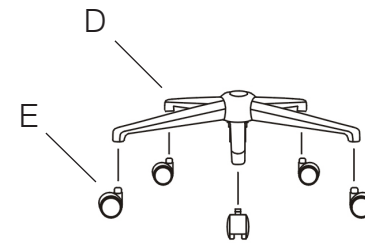

A (1 pc)

B (1 pc)

C (2 pcs)

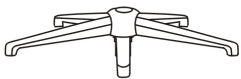

D (1 pc)

E (5 pcs)

F (1 pc)



G (4 pcs)
M10 X 35mm

H (4 pcs)
M10 X 55mm

I (1 pc)
5mm

3

4

5

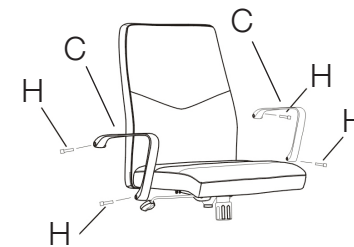
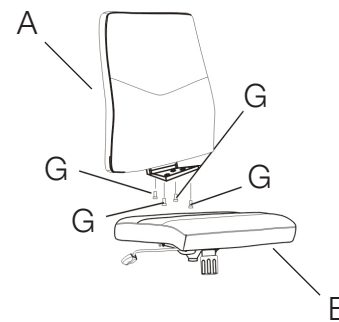

IMPORTANT NOTE: Please find Parts G attached to Part B, rather than in the hardware pack.