

# euøstyle

## Assembly Instructions

### Gilbert 5-Shelf Unit



PLEASE NOTE: Check that you have received all components and hardware before assembling. If you are missing any parts, contact your retailer, or fax Euro Style at 415.455.8033.

During assembly, hand tighten screws only. When all screws are in place, then tighten completely.

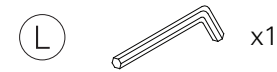
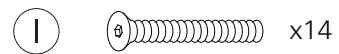
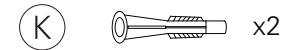
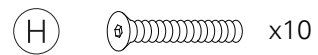
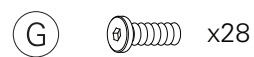
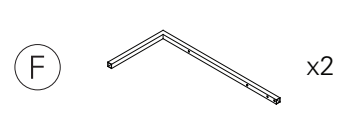
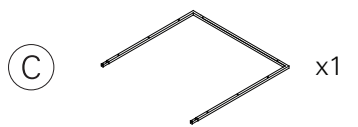
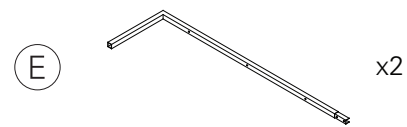
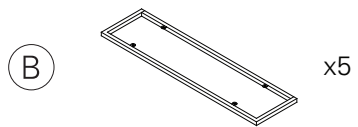
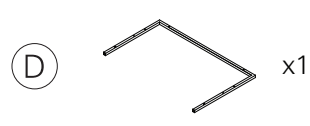
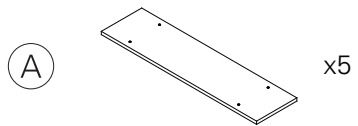
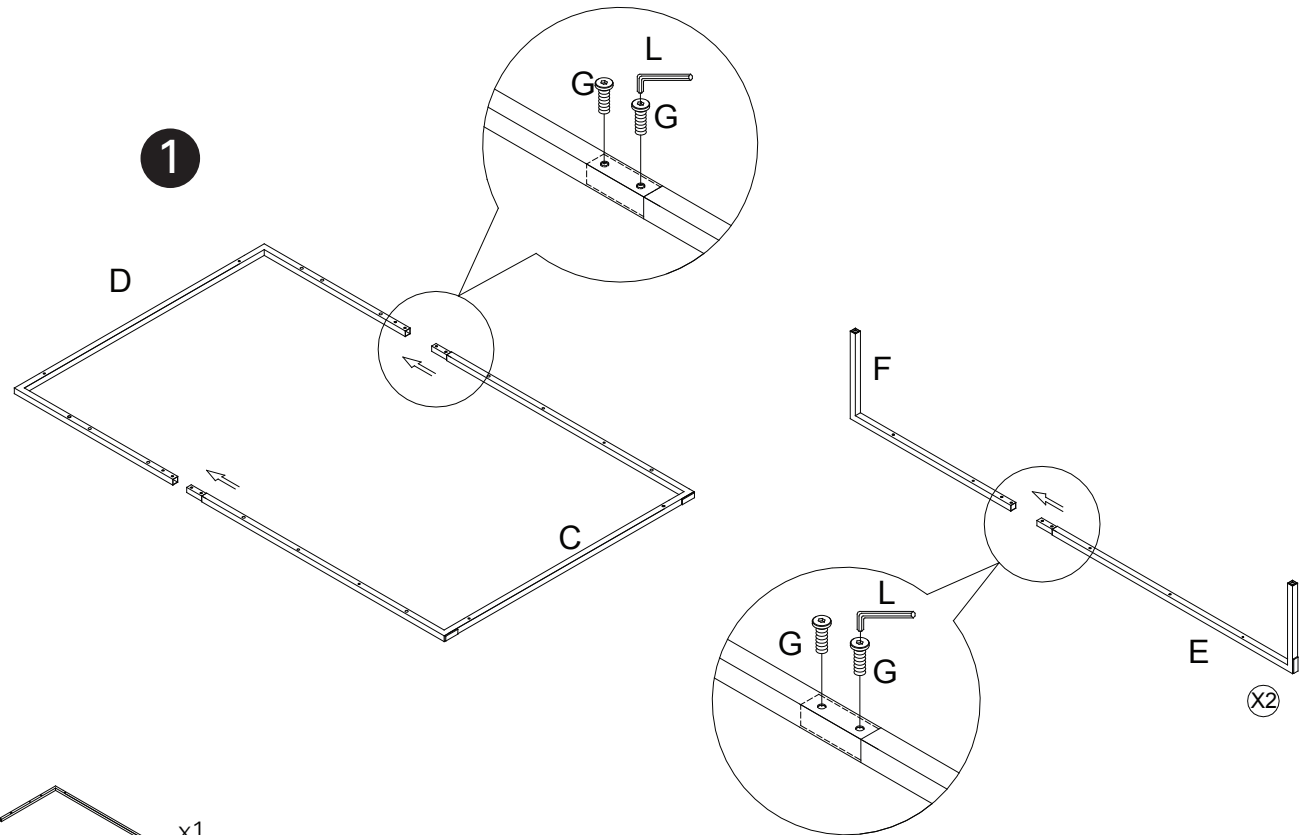

(X2)

