

## Assembly Instructions ERLING Coffee Table

PLEASE NOTE: Check that you have received all components and hardware before assembling.  
If you are missing any parts fax Euro Style at 415.455.8033 or email: [claims@gotoeurostyle.com](mailto:claims@gotoeurostyle.com)

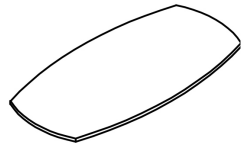

A (1 pc)

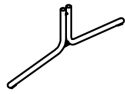

B (1 pc)

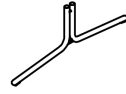

C (1 pc)

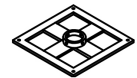

D (1 pc)



E (4 pcs)  
M8 x 12mm



F (4 pcs)  
M6 x 30mm



G (4 pcs)



H (4 pcs)



I (1 pc)  
M8 x 40mm



J (2 pcs)

1

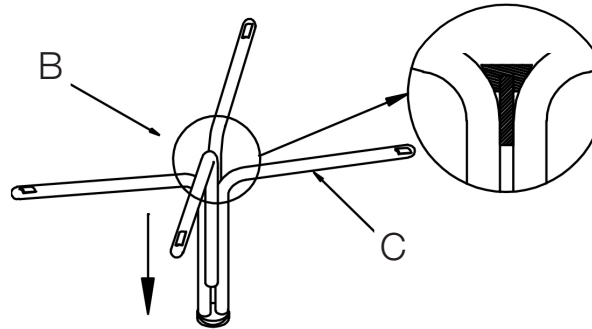

2

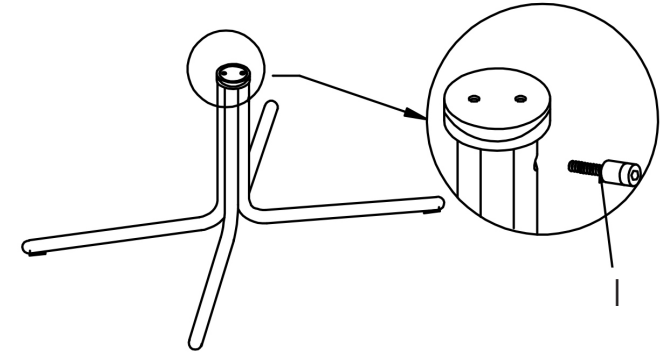

3

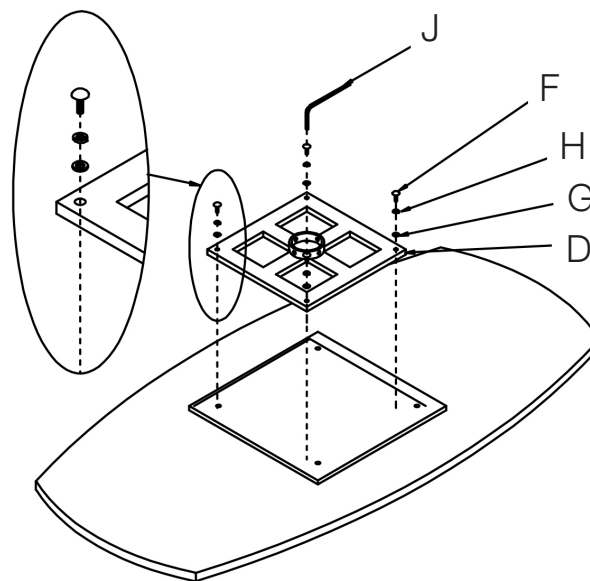

4

